

Informed Search Chapter 4 (a)

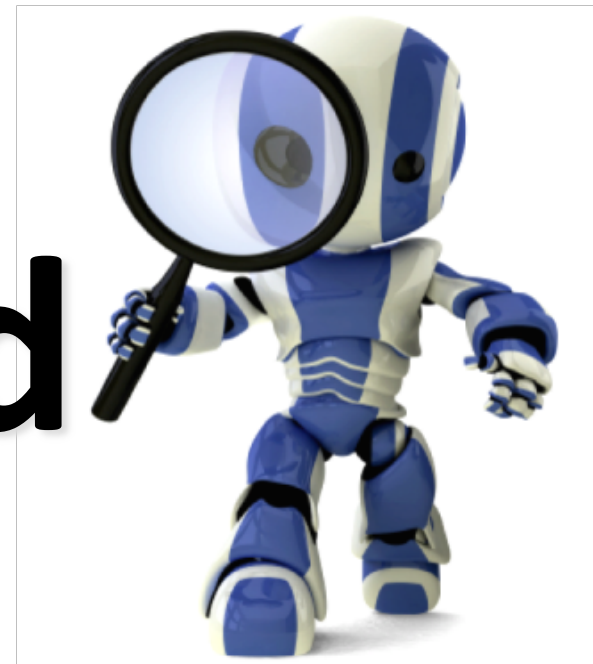

Some material adopted from notes
by Charles R. Dyer, University of
Wisconsin-Madison

Today's class

- Heuristic search
- Best-first search
 - Greedy search
 - Beam search
 - A , A^*
 - Examples
- Memory-conserving variations of A^*
- Heuristic functions

Big idea: heuristic

Merriam-Webster's Online Dictionary

Heuristic (pron. \hyu- 'ris-tik\): adj. [from Greek *heuriskein* to discover] involving or serving as an aid to learning, discovery, or problem-solving by experimental and especially trial-and-error methods

The Free On-line Dictionary of Computing (15Feb98)

heuristic 1. <programming> A **rule of thumb**, simplification or educated guess that reduces or limits the search for solutions in domains that are difficult and poorly understood. Unlike algorithms, heuristics do not guarantee feasible solutions and are often used with no theoretical guarantee. 2. <algorithm> **approximation algorithm**.

From WordNet (r) 1.6

heuristic adj 1: (CS) relating to or using a heuristic rule 2: of or relating to a general formulation that serves to guide investigation [ant: algorithmic]
n : a **commonsense rule** (or set of rules) intended to increase the probability of solving some problem [syn: heuristic rule, heuristic program]

Informed methods add domain-specific information

- Add domain-specific information to select best path along which to continue searching
- Define heuristic function, $h(n)$, that estimates *goodness* of node n
- $h(n)$ = **estimated cost** (or distance) of minimal cost path from n **to a goal state**.
- Based on domain-specific information and computable from current state description that estimates how close we are to a goal

Heuristics

- **All domain knowledge** used in search is encoded in the **heuristic function, $h()$**
- Examples
 - Missionaries & Cannibals: # people on starting river bank
 - 8-puzzle: number of tiles out of place
 - 8-puzzle: sum of distances each tile is from its goal
- In general
 - $h(n) \geq 0$ for all nodes n
 - $h(n) = 0$ implies that n is a goal node
 - $h(n) = \infty$ implies n is a dead-end that can't lead to a goal

Heuristics for 8-puzzle

Current State

1	2	3
4	5	6
7		8

Goal State

1	2	3
4	5	6
7	8	

The number of misplaced tiles (not including the blank)

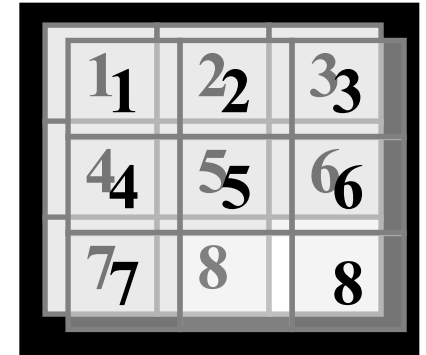

1	2	3
4	5	6
7	8	8

N	N	N
N	N	N
N	Y	

In this case, only “8” is misplaced, so heuristic function evaluates to 1

In other words, the heuristic *says* that it *thinks* a solution might be available in just 1 more move

Heuristics for 8-puzzle

Manhattan Distance (not including the blank)

Current State

3	2	8
4	5	6
7	1	

Goal State

1	2	3
4	5	6
7	8	

3	→	<u>3</u>

2 spaces

	←	8
	↓	
	<u>8</u>	

3 spaces

<u>1</u>	←	
	↑	
	1	

3 spaces

- The **3**, **8** and **1** tiles are misplaced (by 2, 3, and 3 steps) so the heuristic function evaluates to 8
- Heuristic says that it *thinks* a solution is available in just 8 more moves.
- The misplaced heuristic's value is 3

Total 8

We can use heuristics to guide search

In this *hill climbing* example, the Manhattan Distance heuristic helps us quickly find a solution to the 8-puzzle

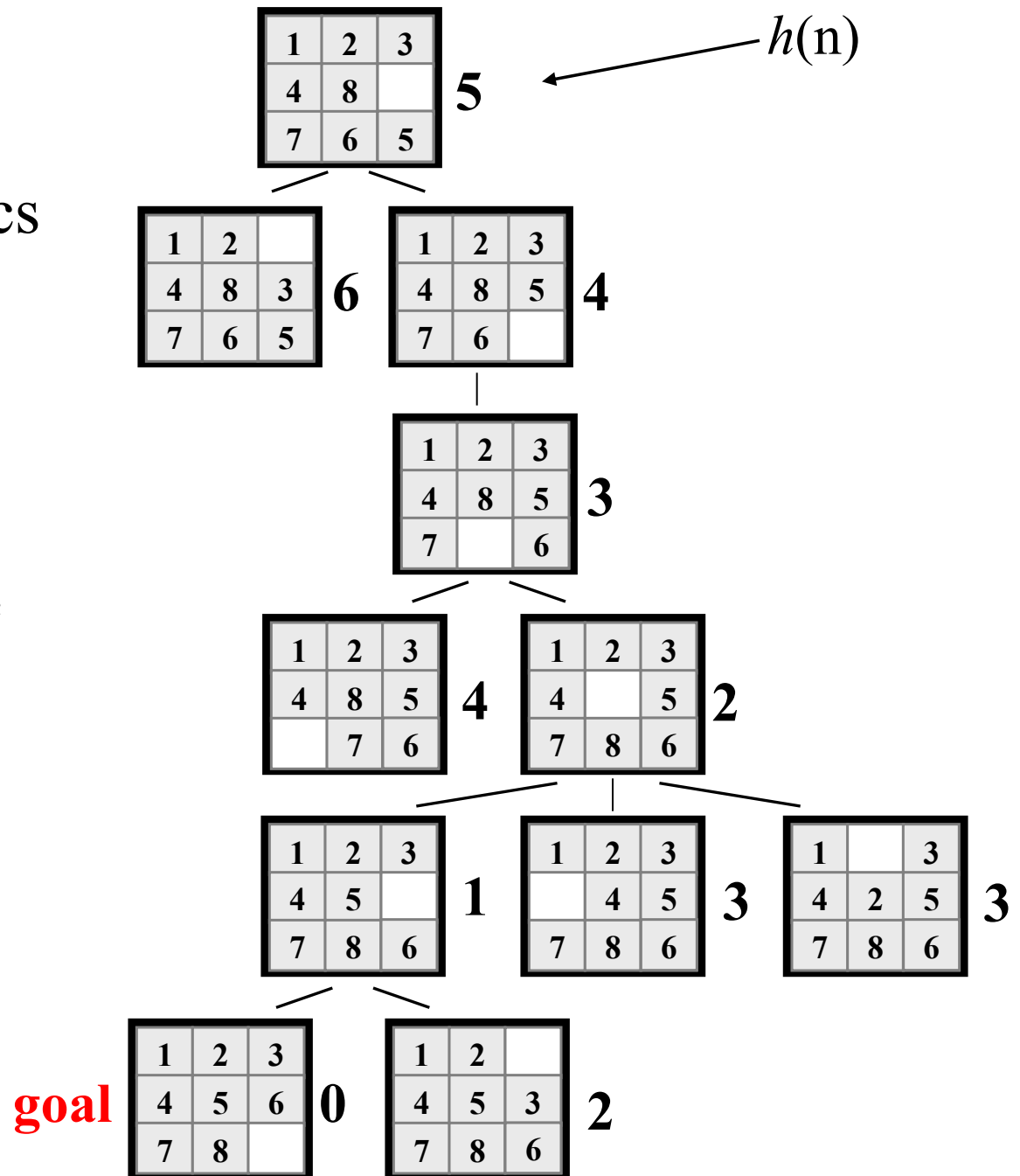

In this example,
hill climbing
doesn't work!

All nodes on
fringe are taking a
step "backwards"
(local minima)

This puzzle *is*
solvable in just 12
more steps

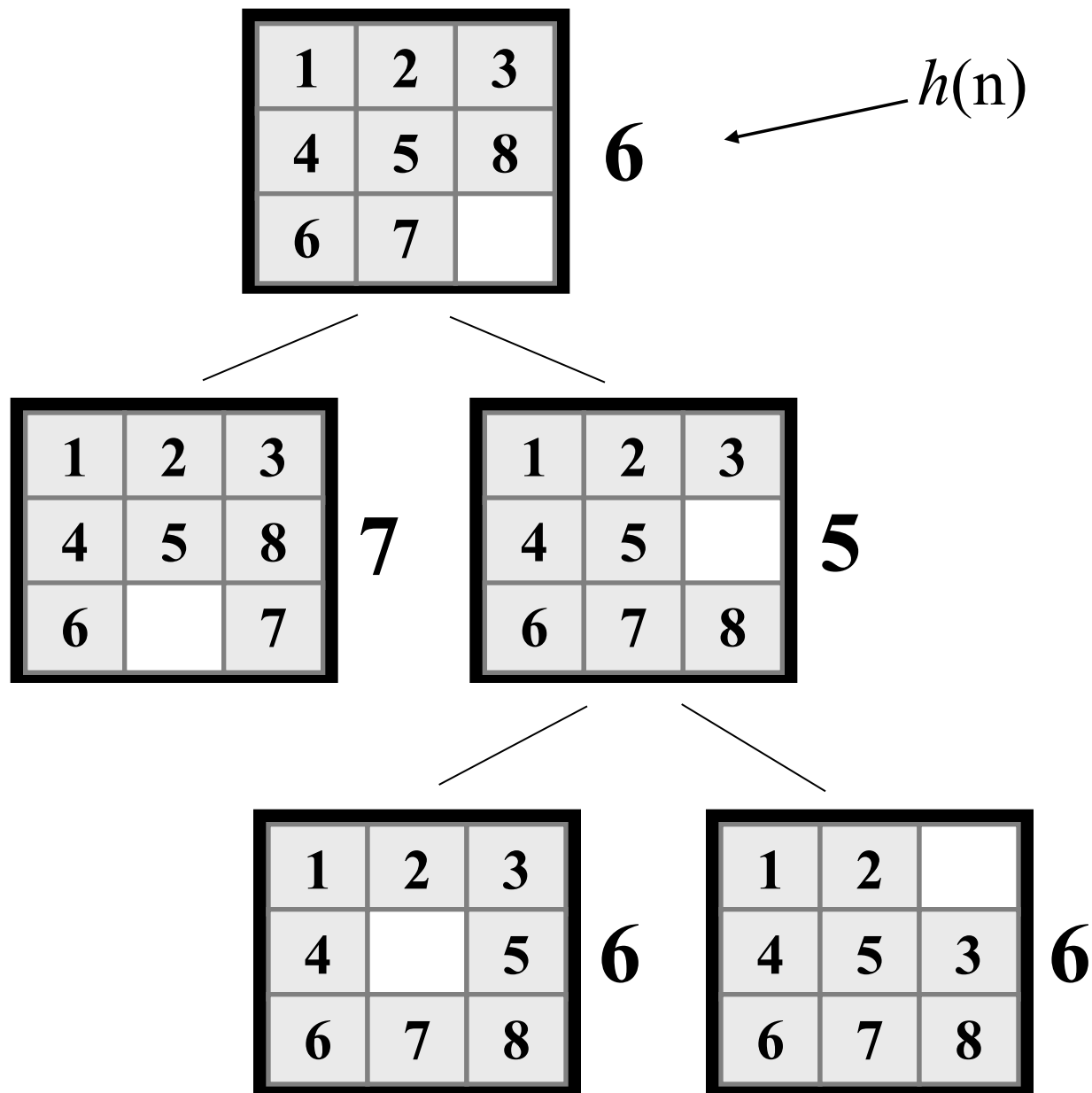

Best-first search

- Search algorithm that optimizes **depth-first search** by expanding most promising node chosen according to heuristic rule
- Order nodes on nodes list by increasing value of an evaluation function, **$f(n)$** , incorporating domain-specific information
- This is a generic way of referring to the class of informed methods

Greedy best first search

- A [greedy algorithm](#) makes locally optimal choices in hope of finding a global optimum
- Uses evaluation function $f(n) = h(n)$, sorting nodes by increasing values of f
- Selects node to expand appearing **closest** to goal (i.e., node with smallest f value)
- Not complete
- Not admissible, as in example
 - Assume arc costs = 1, greedy search finds goal g , with solution cost of 5
 - Optimal solution is path to goal with cost 3

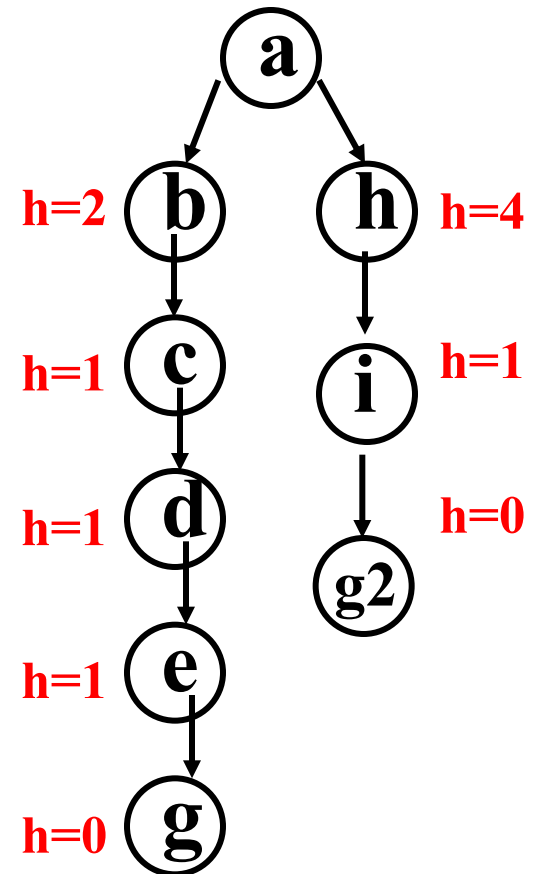

Beam search

- Use evaluation function $f(n)$, but maximum size of the nodes list is k , a fixed constant
- Only keep k best nodes as candidates for expansion, discard rest
- k is the *beam width*
- More space efficient than greedy search, but may discard nodes on a solution path
- As k increases, approaches best first search
- Not complete
- Not admissible (optimal)

Algorithm A

- Use as an evaluation function
$$f(n) = g(n) + h(n)$$
- $g(n)$ = minimal-cost path from the start state to state n
- $g(n)$ term adds “breadth-first” component to evaluation function
- Ranks nodes on search frontier by estimated cost of solution from start node *via given node* to goal
- Not complete if $h(n)$ can = ∞
- Not admissible (optimal)

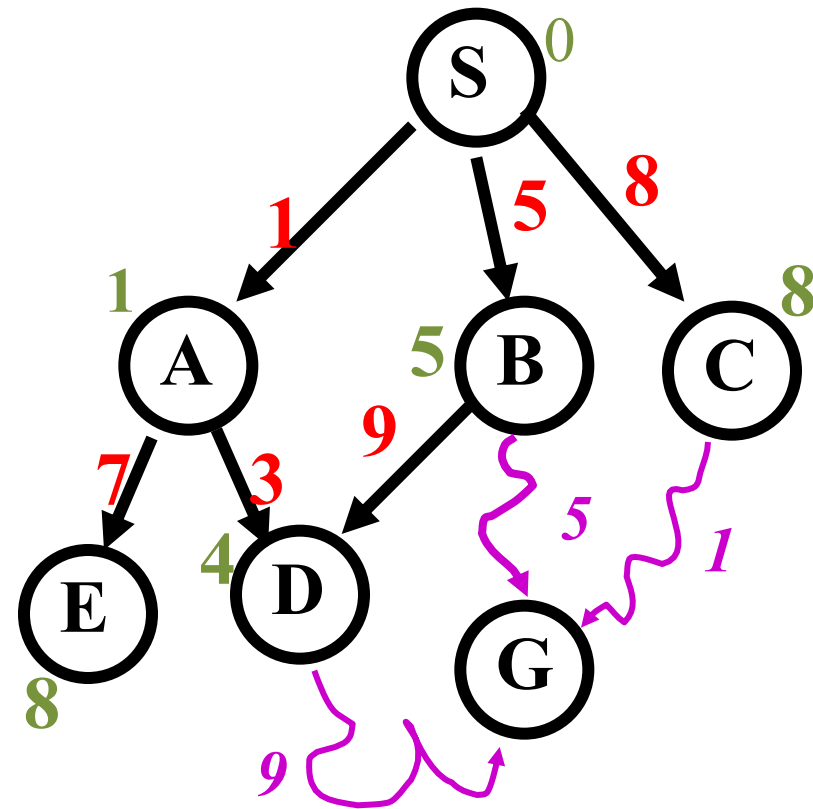

$$g(d)=4$$

$$h(d)=9$$

*C is chosen
next to expand*

Algorithm A

- 1 Put the start node S on the nodes list, called OPEN
- 2 If OPEN is empty, exit with failure
- 3 Select node in OPEN with minimal $f(n)$ and place on CLOSED
- 4 If n is a goal node, collect path back to start and stop
- 5 Expand n , generating all its successors and attach to them pointers back to n . For each successor n' of n
 - 1 If n' not already on OPEN or CLOSED
 - put n' on OPEN
 - compute $h(n')$, $g(n')=g(n)+c(n,n')$, $f(n')=g(n')+h(n')$
 - 2 If n' already on OPEN or CLOSED and if $g(n')$ is lower for new version of n' , then:
 - Redirect pointers backward from n' on path with lower $g(n')$
 - Put n' on OPEN

Algorithm A*

- Pronounced “*a star*”
- Algorithm A with constraint that $h(n) \leq h^*(n)$
- $h^*(n)$ = *true cost of minimal cost path* from n to a goal
- h is **admissible** when $h(n) \leq h^*(n)$ holds
- Using an admissible heuristic guarantees that 1st solution found will be an optimal one
- A* is **complete** whenever branching factor is finite and every action has fixed positive cost
- A* is **admissible**

Observations on A

- **Perfect heuristic:** If $h(n) = h^*(n)$ for all n , then only nodes on an optimal solution path are expanded; no extra work is performed
- **Null heuristic:** If $h(n) = 0$ for all n , then it is an admissible heuristic and A^* acts like uniform-cost search
- **Better heuristic:** If $h_1(n) < h_2(n) \leq h^*(n)$ for all non-goal nodes, then h_2 is a *better* heuristic than h_1
 - If A_1^* uses h_1 , and A_2^* uses h_2 , then every node expanded by A_2^* is also expanded by A_1^*
 - i.e., A_1 expands at least as many nodes as A_2^*
 - We say that A_2^* is *better informed* than A_1^*
- The closer h to h^* , the fewer extra nodes expanded

Example search space

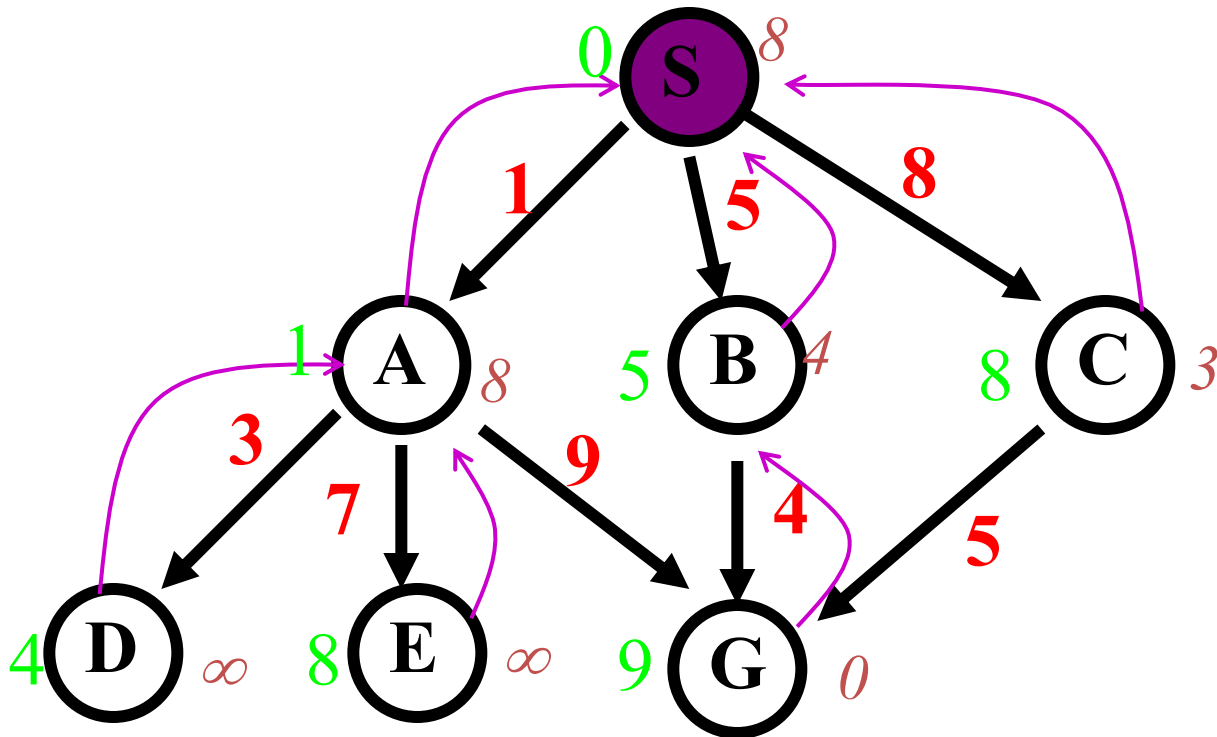

Example search space

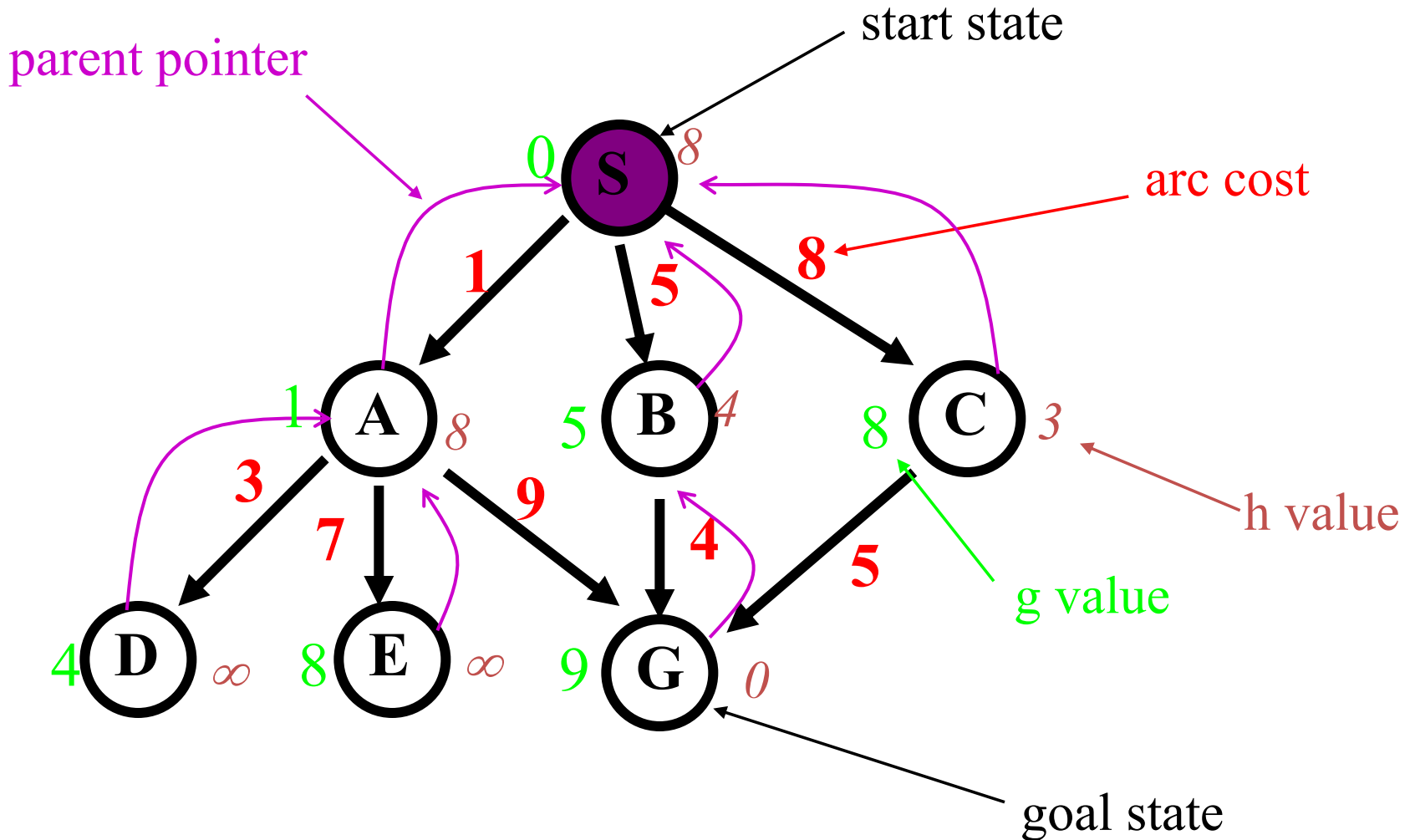

Example

n	g(n)	h(n)	f(n)	h*(n)
S	0	8	8	9
A	1	8	9	9
B	5	4	9	4
C	8	3	11	5
D	4	inf	inf	inf
E	8	inf	inf	inf
G	9	0	9	0

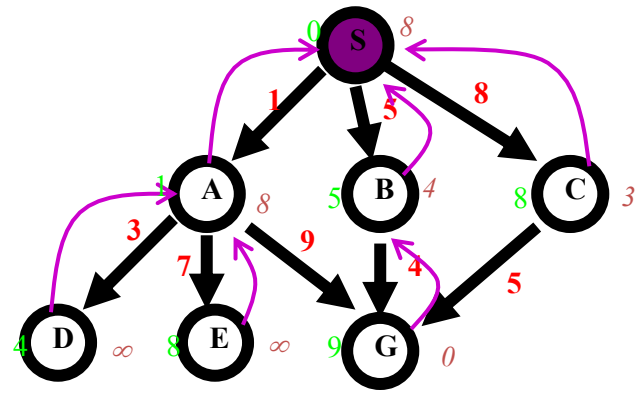

- $h^*(n)$ is (hypothetical) perfect heuristic (an oracle)
- Since $h(n) \leq h^*(n)$ for all n , h is admissible (optimal)
- Optimal path = $S B G$ with cost 9

Greedy search

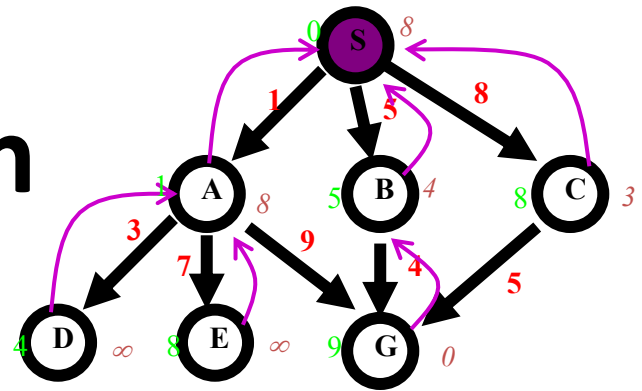

$$f(n) = h(n)$$

node expanded

nodes list

	{ S (8) }
S	{ C (3) B (4) A (8) }
C	{ G (0) B (4) A (8) }
G	{ B (4) A (8) }

- Solution path found is S C G, 3 nodes expanded.
- See how fast the search is!! But it is NOT optimal.

A* search

$$f(n) = g(n) + h(n)$$

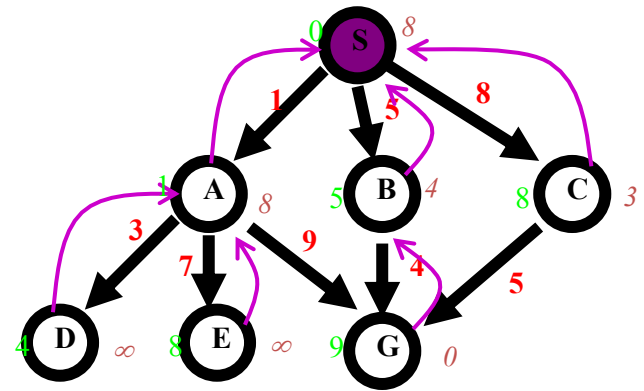

node exp.

nodes list

{ S(8) }

S { A(9) B(9) C(11) }

A { B(9) G(10) C(11) D(inf) E(inf) }

B { G(9) G(10) C(11) D(inf) E(inf) }

G { C(11) D(inf) E(inf) }

- Solution path found is S B G, 4 nodes expanded..
- Still pretty fast. And optimal, too.

Proof of the optimality of A^*

- Assume that A^* has selected $G2$, a goal state with a suboptimal solution, i.e., $g(G2) > f^*$
- Proof by contradiction shows it's impossible
 - Choose a node n on an optimal path to G
 - Because $h(n)$ is admissible, $f^* \geq f(n)$
 - If we choose $G2$ instead of n for expansion, then $f(n) \geq f(G2)$
 - This implies $f^* \geq f(G2)$
 - $G2$ is a goal state: $h(G2) = 0$, $f(G2) = g(G2)$.
 - Therefore $f^* \geq g(G2)$
 - Contradiction

Dealing with hard problems

- For large problems, A^* may require too much space
- Variations conserve memory: IDA* and SMA*
- IDA*, iterative deepening A^* , uses successive iteration with growing limits on f , e.g.
 - A^* but don't consider a node n where $f(n) > 10$
 - A^* but don't consider a node n where $f(n) > 20$
 - A^* but don't consider a node n where $f(n) > 30, \dots$
- SMA* -- Simplified Memory-Bounded A^*
 - Uses queue of restricted size to limit memory use

How to find good heuristics

- If $h_1(n) < h_2(n) \leq h^*(n)$ for all n , h_2 is better than (**dominates**) h_1
- **Relaxing problem:** remove constraints for easier problem; use its solution cost as heuristic function
- max of two admissible heuristics is an a **Combining heuristics:** dmissible heuristic, and it's better!
- Use statistical estimates to compute h ; may lose admissibility
- Identify good features, then use **machine learning** to find heuristic function; also may lose admissibility

Summary: Informed search

- **Best-first search** is general search where minimum-cost nodes (w.r.t. some measure) are expanded first
- **Greedy search** uses minimal estimated cost $h(n)$ to goal state as measure; reduces search time, but is neither complete nor optimal
- **A* search** combines uniform-cost search & greedy search: $f(n) = g(n) + h(n)$. Handles state repetitions & $h(n)$ never overestimates
 - A* is complete & optimal, but space complexity high
 - Time complexity depends on quality of heuristic function
 - IDA* and SMA* reduce the memory requirements of A*